

ASSEMBLY INSTRUCTIONS

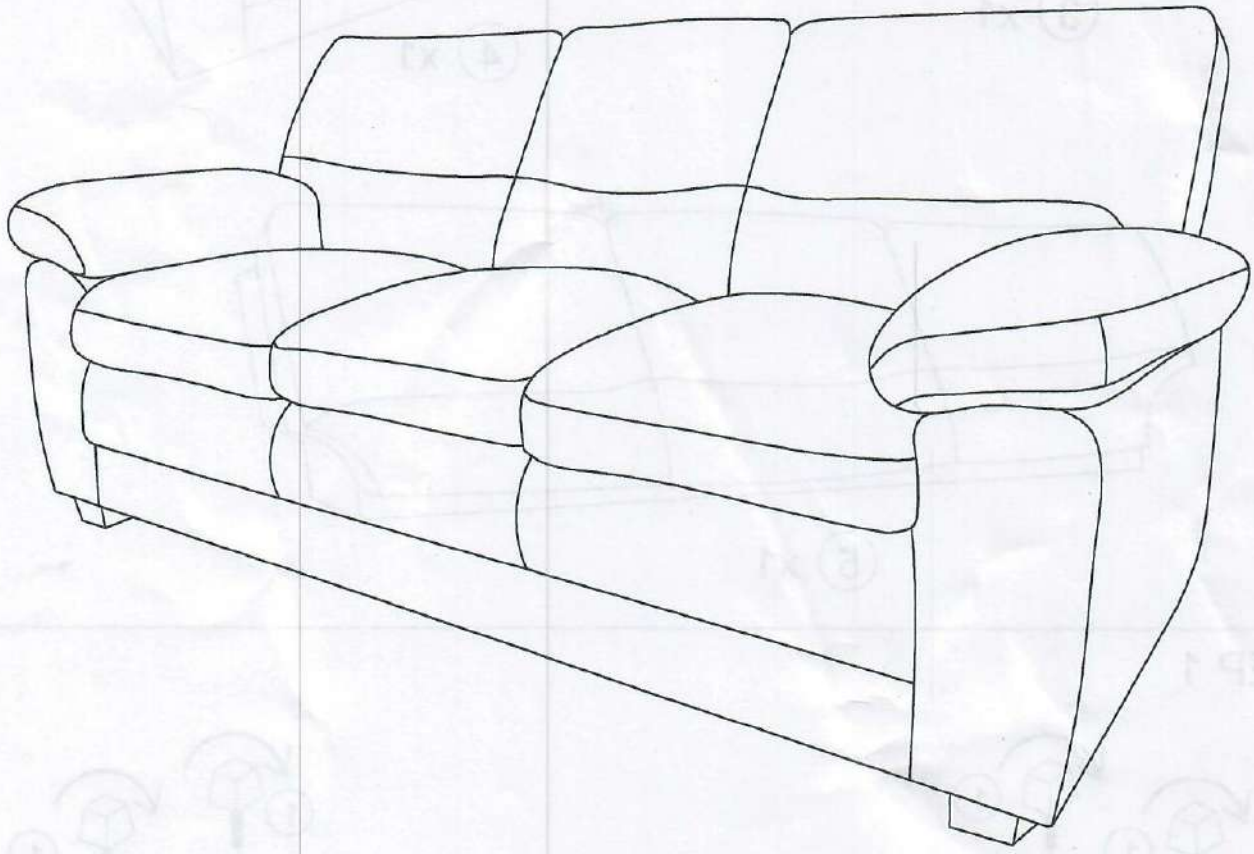

PARTS AND HARDWARE

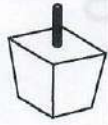

① x4

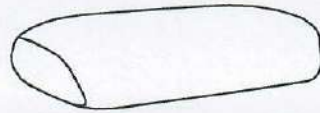

② x1

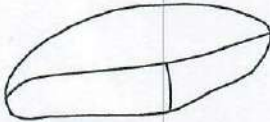

③ x1

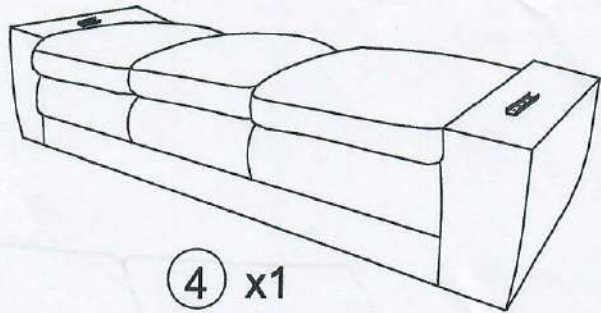

④ x1

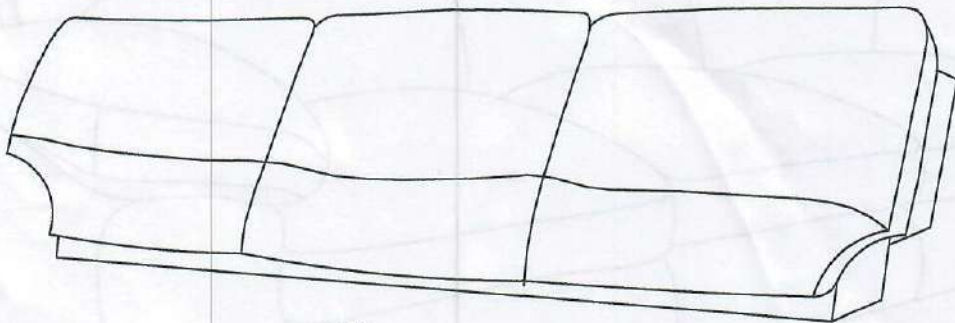

⑤ x1

STEP 1

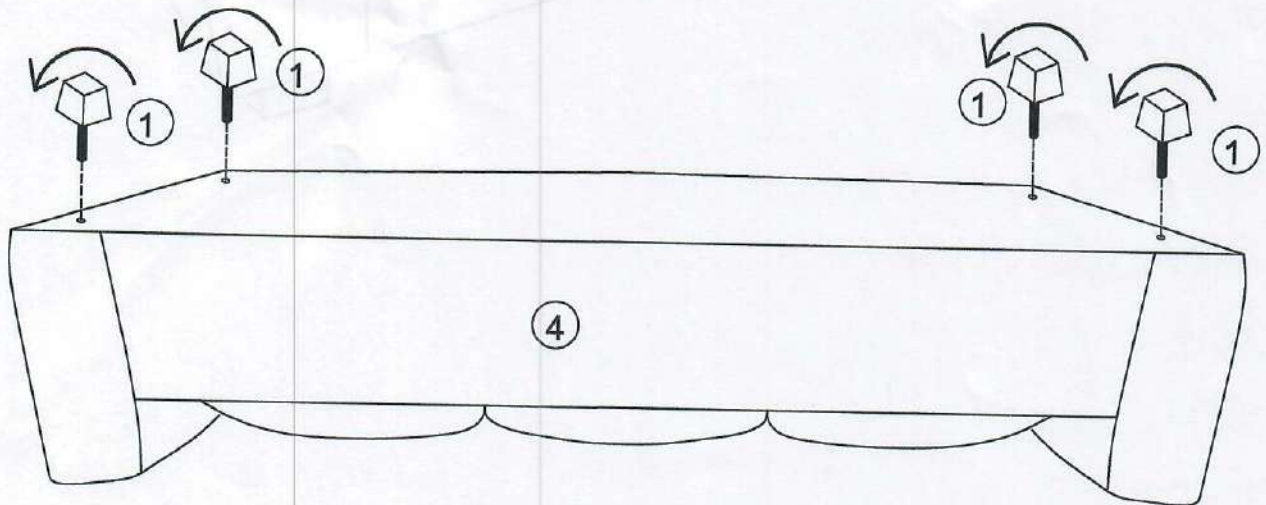

STEP 2

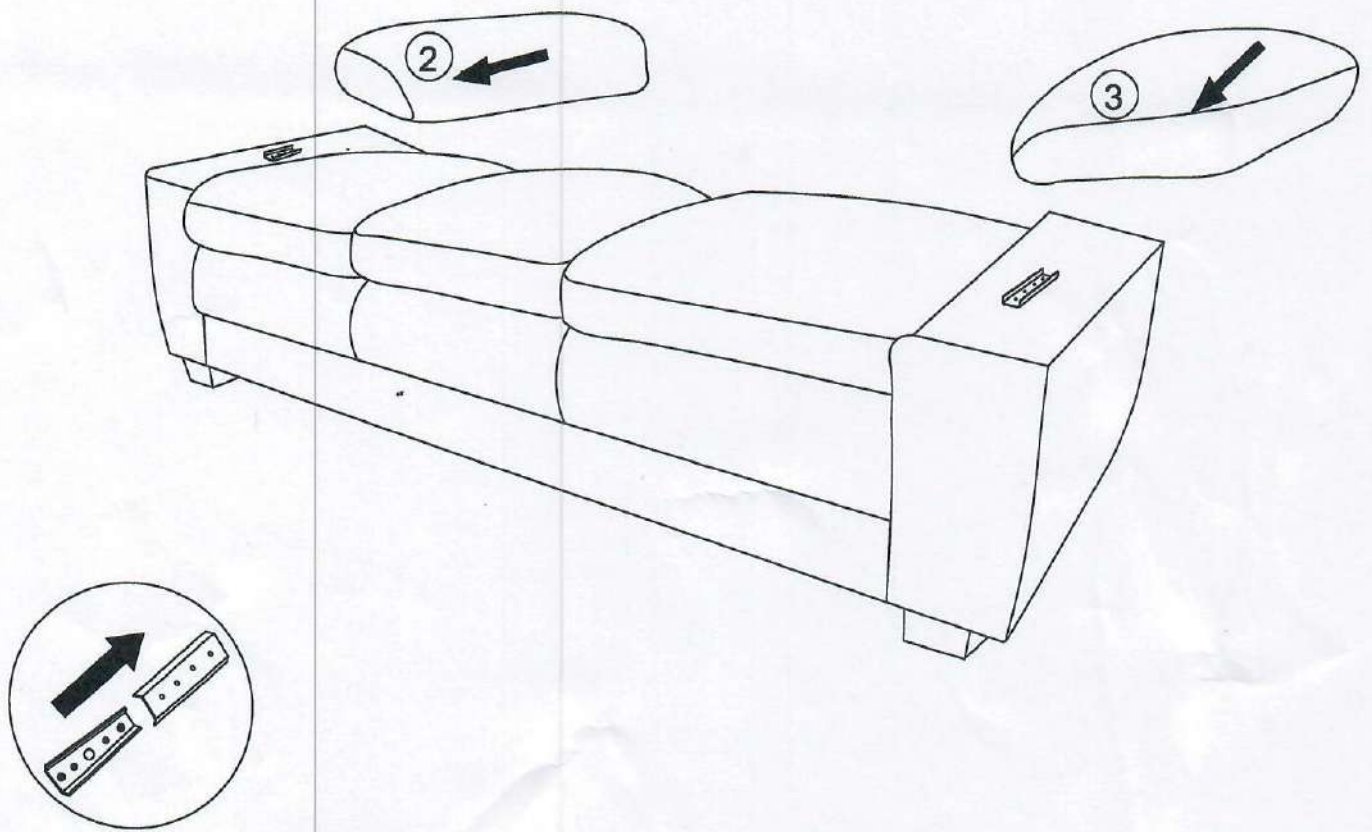

STEP 3

